



KONICA MINOLTA

LASER IMAGER
DRYPRO
MODEL 832



The essentials of imaging

SMALL AND SOPHISTICATED

Konica Minolta technology pursues the ultimate performance in dry medical laser imagers. With the DRYPRO 832, superior image quality, ultra-high speed printing and increased cost effectiveness are all included in this very compact laser imager.

The DRYPRO 832 dry laser imager is more than just a compact printer. It delivers excellent productivity, boasting an unparalleled time to first print of 50 seconds and support of five film sizes - from 14X17 in. to 8X10 in. This full-spec, "tabletop," laser imager doesn't sacrifice performance or versatility.



World's fastest first printing time^{※1}

Time to first print, a major speed and productivity parameter, has been greatly improved to a short 50 seconds, dramatically enhancing productivity and workflow.

※1: as of March 2007

Five film sizes and two trays^{※2}

Five film sizes are available (14X17 in., 14X14 in., 11X14 in., 10X12 in., and 8X10 in.) And by installing an additional film supply tray, two film sizes can be used at the same time, for example, 14 X17 in. and 11X14 in., or 14X17 in. and 8x10 in..

※2:Optional

User-friendly

The DRYPRO 832 is very user friendly. It is easy to use, warms up quickly, and is very quiet.

A clearly visible status light changes color to indicate "Ready", "Printing", and "Film Empty" conditions.

Environment-friendly design

The excellent low-noise design assures a pleasant environment. The actual running noise has been tuned to a low tone with a reduced high-temperature range, so that it gives the impression of being quieter than it actually is. While the overall noise

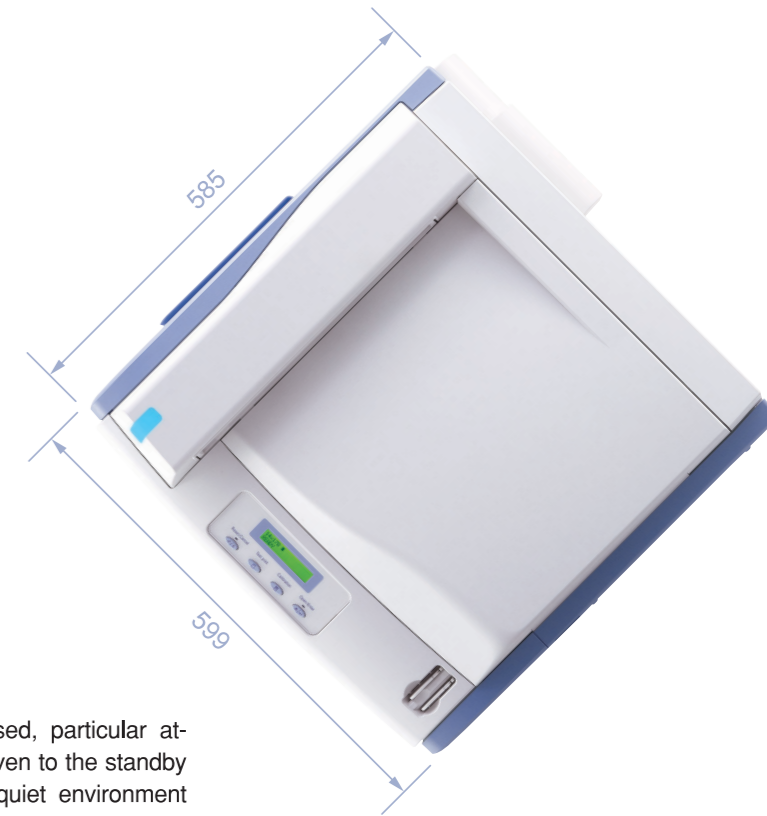

has been suppressed, particular attention has been given to the standby noise, ensuring a quiet environment for clinics where standby operation accounts for most of the usage time.

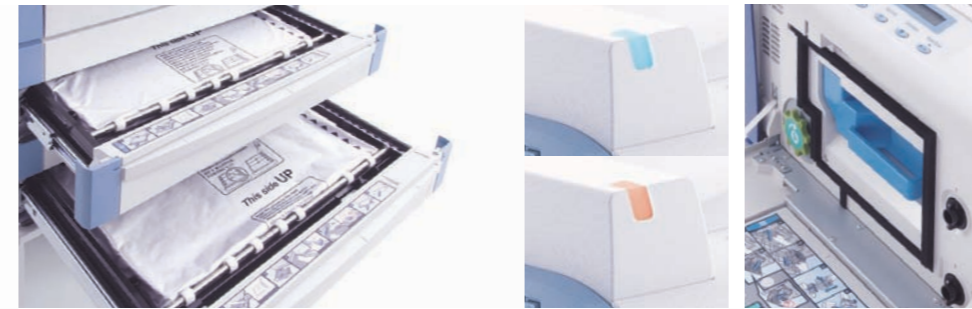

Example for Connectivity Layout

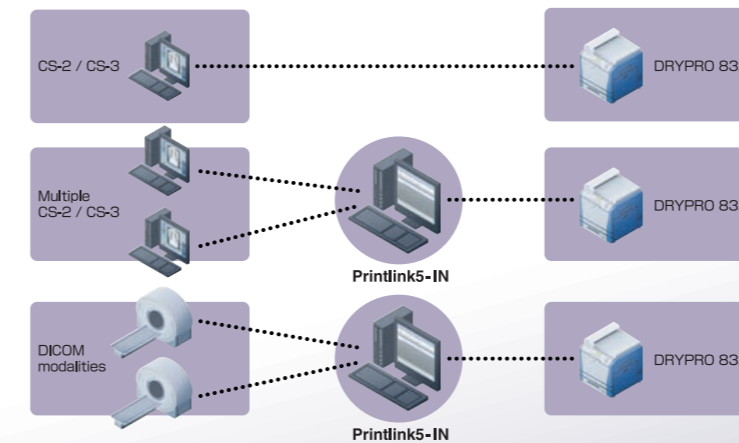

Storing and Handling Dry Film

Dry image recording film SD-Q / SD-QC does not require a WET process. When storing and handling film, be sure to observe the following.

1. Storing and handling unused film

After confirming that film is packaged, store unused film, like ordinary film, in a cool, dark place (recommended temperature: 10-23°C (50-73°F)) where it will not be affected by radiation. If film is stored in a place where temperature is more than 30°C (86°F) for a long period of time, the quality of the film may change. When storing film in a film storage, it should be stored in a place where temperature is not likely to rise.

2. Storing and handling processed film (image)

(1) As heat-processed-type film is susceptible to high temperature or strong sunlight even after it's processed, it should be stored in a cool, dark place. When storing film for a long period of time, be sure to place it in a film bag and store it in a place where temperature is 25°C (77°F) or below. The rise in density or discoloration may occur more frequently as the temperature rises.
(2) If the film is stored at a temperature of 40°C (104°F) or higher, this may cause density changes or discoloration even over a short period of storage. Avoid leaving the film in a car

in daytime, or using it with a hot lamp etc.
(3) As the film is susceptible to strong sunlight as well as temperature, avoid exposing it to direct sunlight, or leaving it on a viewing screen for a long time.

Dry film should not be cleaned with alcohol or cleaning agents that may cause density blotching and other defects. The film is resistant to water, so it may be cleaned with a soft cloth dampened with water.



available 5 sizes

DRYPRO MODEL 832

Stable operation with no HDD

Hard drives store system software and data and, with that, there is always a risk that the disc will crash, bringing operation to a standstill. With the DRYPRO 832, we have eliminated the hard drive and introduced a design where the essential system software is run from compact flash memory and image data is managed by an external computer (CS-2/3 or Printlink5-IN), thereby contributing to stable operation.

Networking by Printlink

With its flexible networking capability, the Printlink print management system provides the ideal output solution in a variety of environments, enabling output from multiple Regius consoles (CS-2/3) and printing from DICOM modalities. By using Printlink IV / ID (sold separately), you can also connect to non-DICOM modalities.

Comparison of density resolution

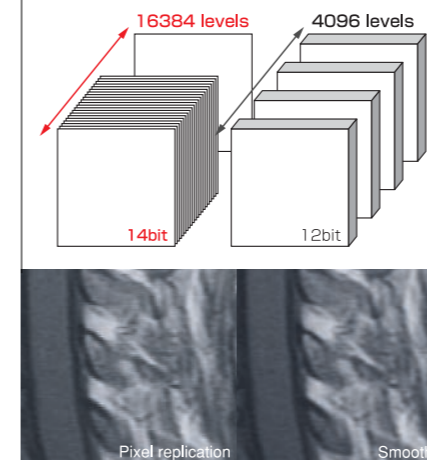

High-quality images

A semiconductor laser and precision optics are merged to produce 78.6µm pixel size resulting in sharp, high-definition films. The DRYPRO 832 accepts 8-bit or 12-bit data and outputs with 14-bit density resolution to accurately reproduce the highest resolution images such as those from Regius CR.

Stable finished quality

The DRYPRO 832's density control function maintains the output density by automatically measuring a small density patch on every film. The system also automatically calibrates itself whenever a new box of film is loaded.

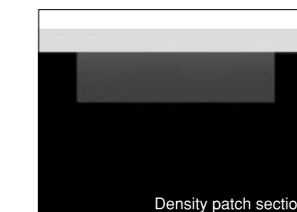

Density patch section

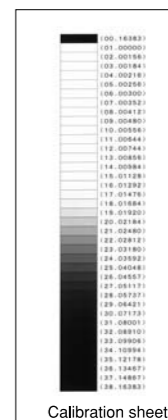

Calibration sheet

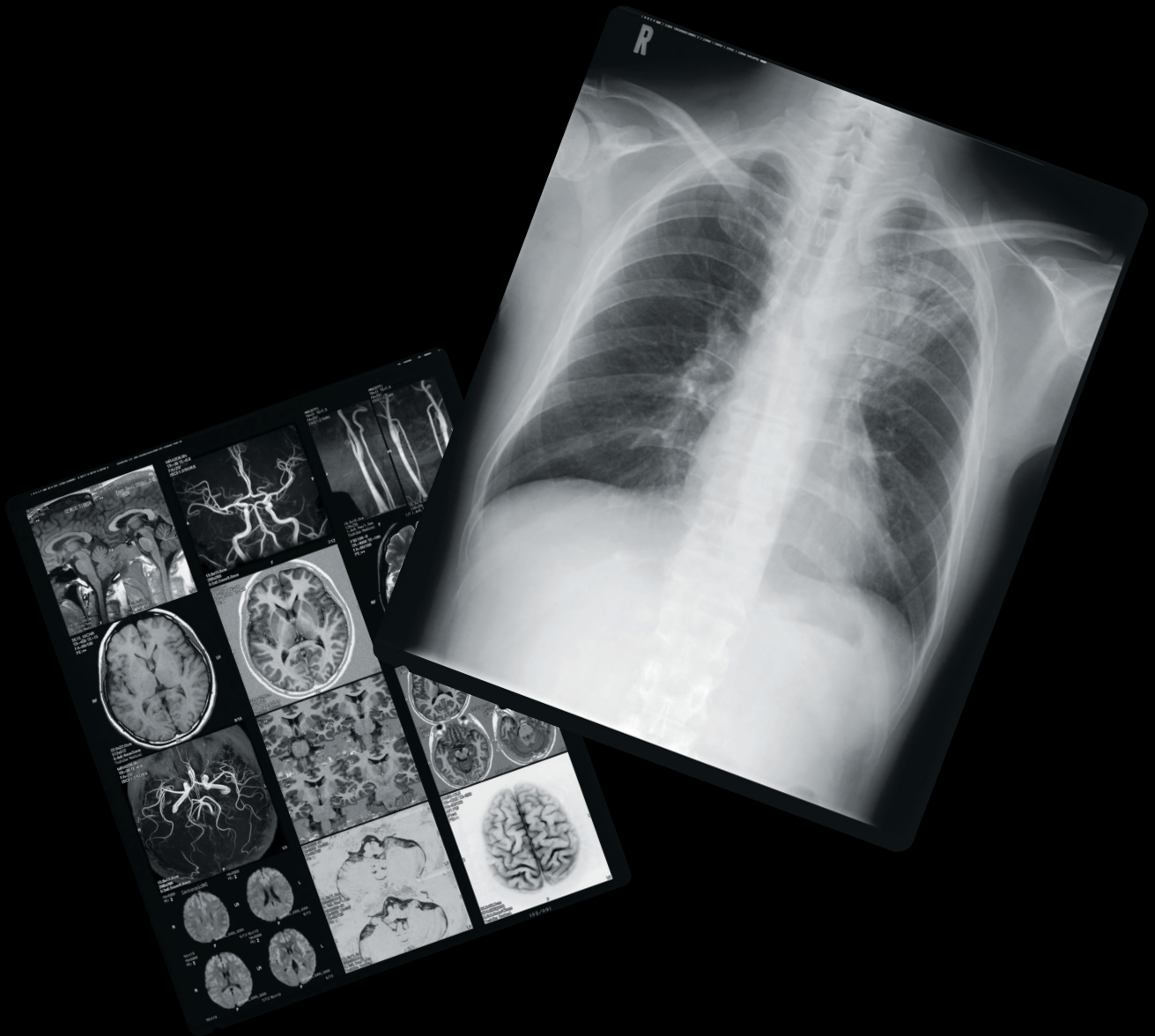

C O M P A C T & F U L L S P E C .

**The DRYPRO 832 occupys a mere 0.35m²
enabling more efficient use of space.**

LASER IMAGER DRYPRO MODEL 832

Specifications of DRYPRO MODEL 832

Laser Source	Semiconductor laser
Film Size	14"×17"(35×43cm), 14"×14"(35×35cm), 11"×14"(28×35cm), 10"×12"(25×30cm) and 8"×10"(20×25cm) selectable
Film	Dry Imaging recording film SD-Q / SD-QC
Image Format	1,2,4,6,8,9,12,15,16,20,24,25,30,35,36,42,48,54,60,63,64
Image Memory	Print memory (64MB / standard)
Pixel Size	78.6μm (320dpi)
Image data input	8bit / 12bit
Output gradation	16384 levels (14bits)
Image Mode	Pixel replication / Function interpolation process
Processing capability	More than 90sheets / hour
First Printing Time	less than 50sec
Input interface	Ethernet 10base-T / 100 base-TX / 1000base-T
External connection	Connection to external computer (CS-2/3 or Printlink5-IN)
Supply	1 Tray (standard) 2 Tray maximum (optional)
Border processing	Black / White
Trimmed frame	Available
Density correction	Automatic via built-in densitometer
Positive / negative	Available
Operating condition	15-30°C(59-86F) 30-70% RH
Power	UL : 120V AC± 10% 60Hz±1Hz 10A CE : 220-240V AC± 10% 50/60Hz± 1Hz 6A
Heat generation	UL : 1200KJ/H or less CE : 1400KJ/H or less
Noise Level	In print Mode : 53 dB or less In standby mode : 46 dB or less
Dimensions	W599×D585×H570 mm *with 1 Tray W599×D585×H722 mm *with 2 Tray
Footprint	0.35m ²
Weight	approx. 95kg (209lb) *with 1 Tray approx. 117kg (258lb) *with 2 Tray
Accessories	Power Cable, Operation Manual, Cutter (for film loading)

Specifications of Printlink5-IN

Protocol	DICOM Print Management
DICOM connection	Print Service Class (Basic Gray Scale) / Presentaion LUT Service Class / Storage Service Class
Number of Input / Output channel	8 channels maximum (7 input channels maximum when 1 DRYPRO832 is connected)

Outer dimensions

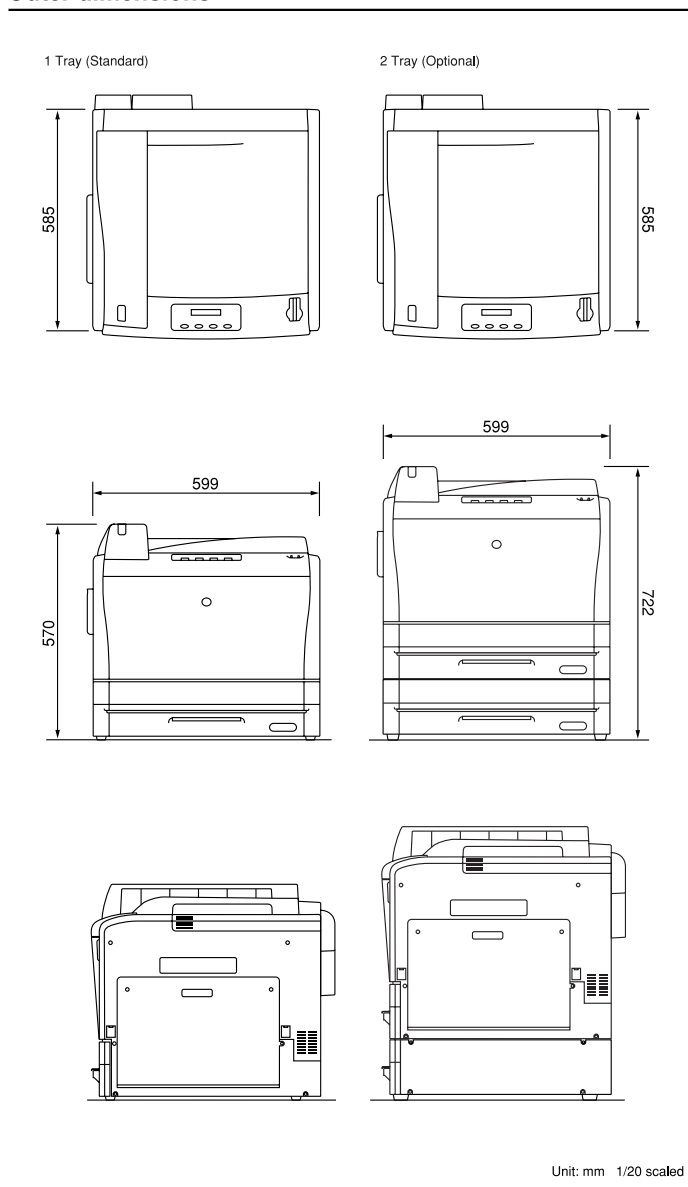

★In order to improve the performance, the specifications above are subject to change without notice.



KONICA MINOLTA

KONICA MINOLTA MEDICAL & GRAPHIC, INC.

No.1, Sakura-machi, Hino-shi, Tokyo, 191-8511, Japan

Distributed by :